



Scheda Tecnica - Technical Sheet

# Adattatore triplo

*Triple adapter plug*



Art.  
**300609B**  
**300609N**

**Adattatore triplo**  
**2P+T 16A~ 250V**  
**2P+T 10/16A~ 250V**

Dimensioni:  
Size: **46x48xh57 mm**

**Spina 2P+T 16A~ 250V**  
**3x Presa 2P+T 10/16A~ 250V**  
*Plug 2P+T 16A~ 250V*  
*3x Socket 2P+T 10/16 A~ 250V*

**Colori: Bianco - Nero**  
*Colours: White - Black*

**Corpo in polimero**  
**Potenza max 1500W**  
**Spinotti in ottone nichelato**  
**Prese grado prot. 2.1**  
*Polymer body*  
*Max power 1500W*  
*Nickel-plated brass pins*  
*Sockets with protection 2.1*



**Certificazione IMQ**

**NORME: CEI 23-50**  
**CEI 23-57**



Scatolo con stampa in quadricromia  
Giftbox 4 colours

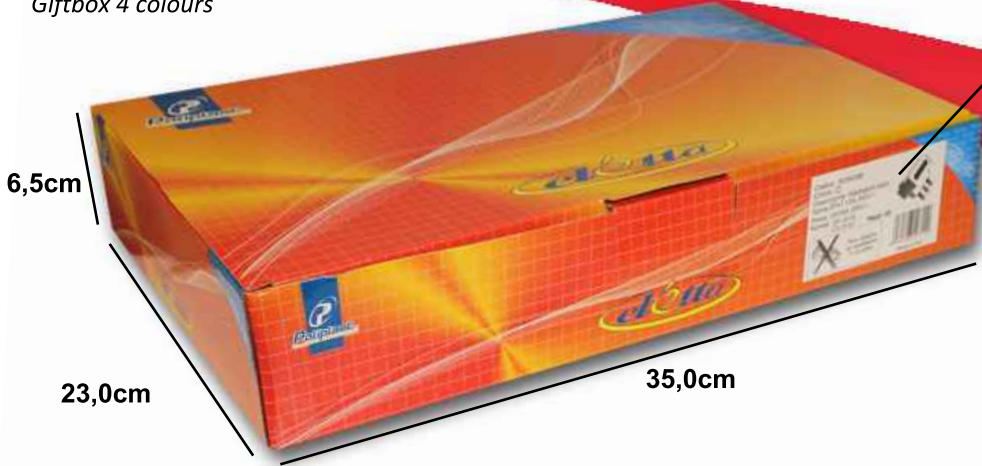

Etichetta  
Label

6,5cm

23,0cm

35,0cm

10 pezzi per ogni busta  
Bag 10 pieces

Scatolo contiene 5 buste trasparente da 10 pezzi  
Giftbox contain 5 transparent bag with 10 pieces

Busta trasparente  
Transparent bag



Etichetta  
Label

## Export Carton/PCS

**Bar Code:**  
Position 4 sides  
in the upper left



**Lateral Sides  
Shipping Mark:**

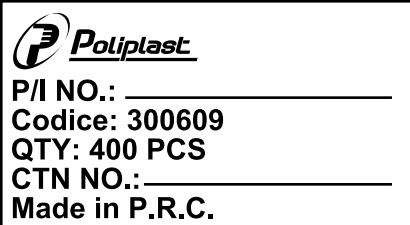

**Central Sides  
Shipping Mark:**

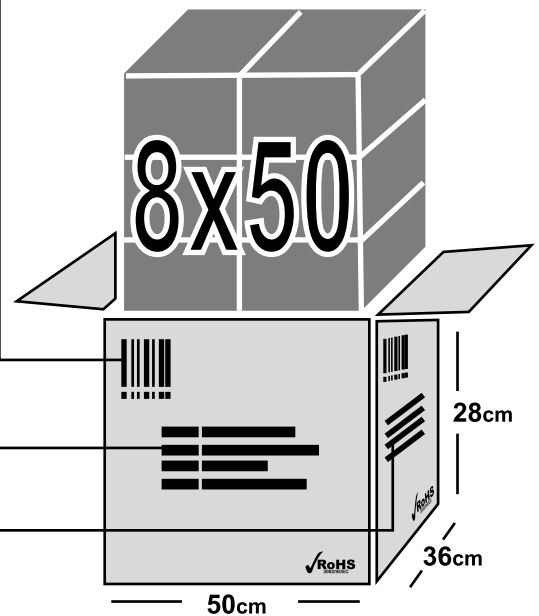
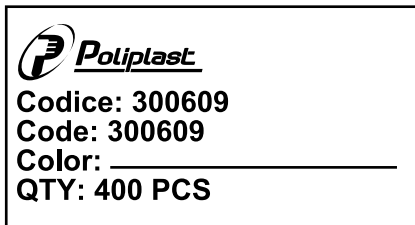

**Corpo in polimero**  
Polymer body

**Preso bivalente 10/16A**  
Bivalent socket 10/16A

**Preso con alveoli**  
con grado di protezione 2.1  
Socket with protection 2.1

**Frutto con spinotti in ottone nichelato**  
Nickel-plated brass pins

**Corpo in polimero**  
Polymer body

**Frutto con spinotti in ottone nichelato**  
Nickel-plated brass pins

**Preso con alveoli**  
con grado di protezione 2.1  
Socket with protection 2.1

**Preso bivalente 10/16A**  
Bivalent socket 10/16A

**Misure**  
Measures

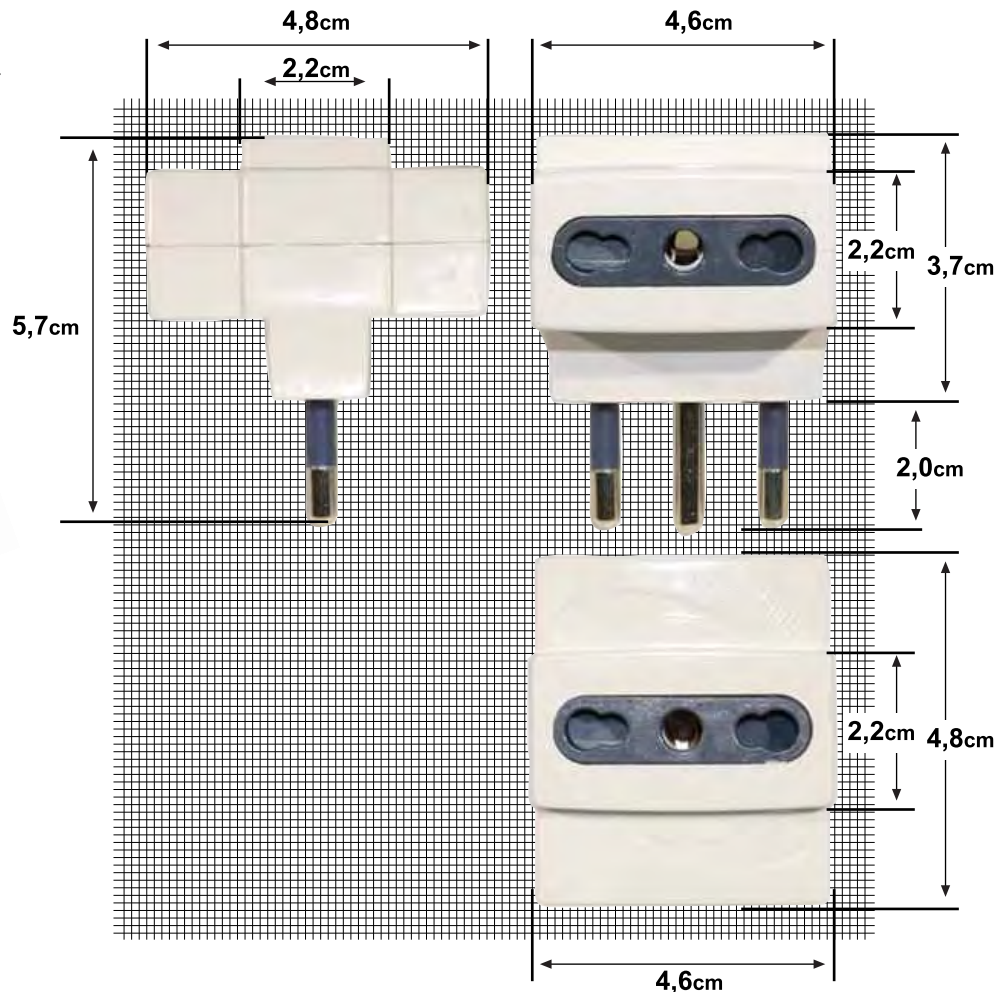
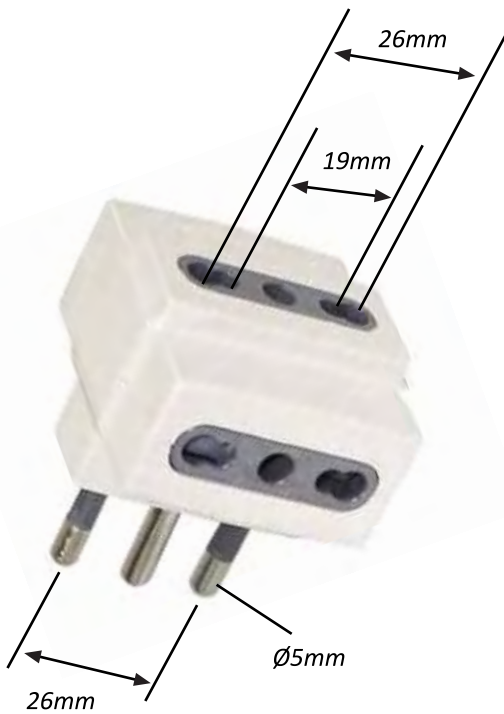

Art. 300609N  
70x50 mm

Etichetta per lo scatolo  
Label for box

Codice: 300609N   
 Colore:    
 Descrizione: Adattatore triplo  
 Spina 2P+T 16A 250V~  
 Presa 2P+T 10/16A 250V~  
 Norme: CEI 23-50  
 CEI 23-57 **Pezzi: 50**







Non inserire  
un adattatore  
in un altro



8 032706 127271  
Made in P.C.R.

Art. 300609B  
70x50 mm

Etichetta per lo scatolo  
Label for box

Codice: 300609B   
 Colore:    
 Descrizione: Adattatore triplo  
 Spina 2P+T 16A 250V~  
 Presa 2P+T 10/16A 250V~  
 Norme: CEI 23-50  
 CEI 23-57 **Pezzi: 50**



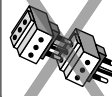





Non inserire  
un adattatore  
in un altro



8 032706 127233  
Made in P.C.R.

 

Codice: 300609N   
 Colore: Nero  
 Descrizione: Adattatore triplo  
 Spina 2P+T 16A 250V~  
 Presa 2P+T 10/16A 250V~  
 Norme: CEI 23-50  
 CEI 23-57  
**Pezzi: 10**  
 Made in P.C.R.



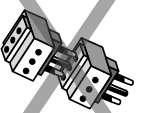



Non inserire  
un adattatore  
in un altro



8 032706 127271

85x40 mm  
Etichetta per la busta  
Label for bag

 

Codice: 300609B   
 Colore: Bianco  
 Descrizione: Adattatore triplo  
 Spina 2P+T 16A 250V~  
 Presa 2P+T 10/16A 250V~  
 Norme: CEI 23-50  
 CEI 23-57  
**Pezzi: 10**  
 Made in P.C.R.



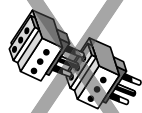

Non inserire  
un adattatore  
in un altro



8 032706 127233

85x40 mm  
Etichetta per la busta  
Label for bag



IMQ S.p.A. Società a Socio Unico  
I-20138 Milano - via Quintiliano, 43  
tel. 0250731(r.a.) - fax 0250991500  
e-mail: info@imq.it - www.imq.it

Rea Milano 1595884  
Registro Imprese MI 12898410159  
C.F./P.I.12898410159  
Capitale Sociale € 4.000.000

**CA02.03812**  
SN.J000D0

0211-4000  
0211-4000  
0211-4000

**Certificato di approvazione**

*Approval certificate*

**IMQ, ente di certificazione accreditato, autorizza la ditta**      *IMQ, accredited certification body, grants to*

**POLIPLAST SRL**  
**ZONA INDUSTRIALE 13esima STRADA N. 34-36**  
**95121 CATANIA CT**

**all'uso del marchio**

*the licence to use the mark*

**IMQ**

Il presente certificato è soggetto alle condizioni previste nel Regolamento "MARCHI IMQ - Regolamento per la certificazione di prodotti" ed è relativo ai prodotti descritti nell'Allegato al presente certificato.



**per i seguenti prodotti**

*for the following products*

**Adattatori per uso domestico**  
**( Rif. di tipo 300609 )**

*Adaptors for domestic purposes*  
*( Type ref. 300609 )*

*This certificate is subjected to the conditions foreseen by Rules "IMQ MARKS - RULES for product certification" and is relevant to the products listed in the annex to this certificate.*

Emesso il / Issued on      **2009-04-22**  
Aggiornato il / Updated on      **2014-10-20**  
Sostituisce / Replaces      **2010-02-16**

  
IMQ S.p.A.

